

ALINCO

VHF/UHF FM TRANSCEIVER

DJ-S17 E/TFH DJ-S47 E

Instruction Manual

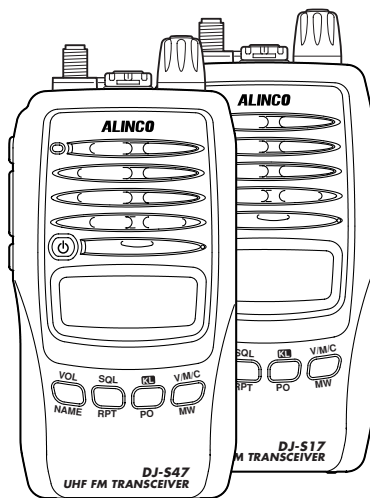

Thank you for purchasing your new Alinco transceiver. This instruction manual contains important safety and operating instructions. Please read this manual carefully before using the product and keep it for future reference.

ALINCO, INC.



NOTICE / Compliance Information Statement



Conformity Information

Alinco, Inc. Electronics Division hereby declare on our sole responsibility that the product(s) listed below comply the essential requirements of the Directive 1999/5/EC, The council of 3/9/99 on Radio Equipment and Telecommunication Terminal Equipment and the mutual recognition of their conformity and with the provisions of Annex, after having performed the required measurements at Notified Bodies per Standards, and relative certificate(s) or document(s) can be reviewed at <http://www.alinco.com/Ce/>

DJ-S17E: VHF FM Transceiver 144.000~145.995MHz

DJ-S47E: UHF FM Transceiver 430.000~439.995MHz









This device is authorized for use in all EU and EFTA member states. An operator's license is required for this device.

Copyright © All rights reserved. No part of this document may be reproduced, copied, translated or transcribed in any form or by any means without the prior written permission of Alinco. Inc., Osaka, Japan, English Edition Printed in Japan.







Warning





To prevent any hazard during operation of Alinco's radio product, in this manual and on the product you may find symbols shown below. Please read and understand the meanings of these symbols before starting to use the product.

 Danger	This symbol is intended to alert the user to an immediate danger that may cause loss of life and property if the user disregards the warning.
 Alert	This symbol is intended to alert the user to a possible hazard that may cause loss of life and property if the user disregards the warning.
 Caution	This symbol is intended to alert the user to a possible hazard that may cause loss of property or injure the user if the warning is disregarded.
	Alert symbol. An explanation is given.
	Warning symbol. An explanation is given.
	Instruction symbol. An explanation is given.





Alert

■ Environment and condition of use





-  It is recommended that you check local traffic regulations regarding the use of radio equipment while driving. Some countries prohibit or apply restrictions for the operation of radios and mobile- phones while driving.
-  Do not use this product in close proximity to other electronic devices, especially medical ones. It may cause interference to those devices.
-  Keep the radio out of the reach of children.
-  In case a liquid leaks from the product, do not touch it. It may damage your skin. Rinse with plenty of cold water if the liquid contacted your skin.
-  Never operate this product in facilities where radio products are prohibited for use such as aboard aircraft, in airports, in ports, within or near the operating area of business wireless stations or their relay stations.
-  Use of this product may be prohibited or illegal outside of your country. Be informed in advance when you travel.
-  The manufacturer declines any responsibilities against loss of life and/or property due to a failure of this product when used to perform important tasks like life-guarding, surveillance, and rescue.

-  Do not use multiple radios in very close proximity. It may cause interference and/or damage to the product(s).
-  Risk of explosion if battery is replaced with an incorrect type.
-  Dispose of, or recycle used batteries according to your local regulations.
-  The manufacturer declines any responsibilities against loss of life and property due to a failure of this product when used with or as a part of a device made by third parties.
-  Use of third party accessory may result in damage to this product. It will void our warranty for repair.



■ Handling this product





-  Be sure to reduce the audio output level to minimum before using an earphone or a headset. Excessive audio may damage hearing.
-  Do not open the unit without permission or instruction from the manufacturer. Unauthorized modification or repair may result in electric shock, fire and/or malfunction.
-  Do not operate this product in a wet place such as shower room. It may result in electric shock, fire and/or malfunction.
-  Do not place the product in a container carrying conductive materials, such as water or metal in close proximity to the product. A short-circuit to the product may result in electric shock, fire and/or malfunction.

■ About chargers



-  Do not use adapters other than having the specified voltage. It may result in electric shock, fire and/or malfunction.
-  Do not plug multiple devices using an adapter into a single wall outlet. It may result in overheating and/or fire.
-  Do not handle adapter with a wet hand. It may result in electric shock.
-  Securely plug the adapter into the wall outlet. Insecure installation may result in short-circuit, electronic shock and/or fire.
-  Do not use the adapter if the plug or socket contacts are dirty. Overheating and/or short-circuiting may result in fire, electric shock and/or damage to the product.

■ About power supply

-  Use only appropriate, reliable power supply of correct voltage and capacity.
-  Do not connect cables in reverse polarity. It may result in electric shock, fire and/or malfunction.
-  Do not plug multiple devices including the power supply into a single wall outlet. It may result in overheating and/or fire.

-  Do not handle a power supply with a wet hand. It may result in electric shock.
-  Securely plug the power supply to the wall outlet. Insecure installation may result in short-circuiting, electronic shock and/or fire.
-  Do not plug the power supply into the wall socket if the contacts are dirty. Short-circuit and/or overheating may result in fire, electric shock and/or damage to the product.
-  Do not modify or remove fuse-assembly from the DC cable. It may result in fire, electric shock and/or damage to the product.

■ Cigar-lighter cable

-  Do not use the cable at any other than the specified voltage. It may result in electric shock, fire and/or malfunction.
-  Do not handle cigar cable with a wet hand. It may result in electric shock.

■ In case of emergency

In case of the following situation(s), please turn off the product, switch off the source of power, then remove or unplug the power-cord. Please contact your local dealer of this product for service and assistance. Do not use the product until the trouble is resolved. Do not try to troubleshoot the problem by yourself.

- When a strange sound, smoke and/or strange odor comes out of the product.
- When the product is dropped or the case is broken or cracked.
- When a liquid penetrated inside.
- When a power cord (including DC cables, AC cables and adapters) is damaged.

-  For your safety, turn off then remove all related AC lines to the product and its accessories from the wall outlet if a thunderstorm is likely.





■ Maintenance

-  Do not open the unit and its accessories. Please consult with your local dealer of this product for service and assistance.







Caution





■ Environment and condition of use

-  Do not use the product in proximity to a TV or a radio. It may cause interference or receive interference.
-  Do not install in a humid, dusty or insufficiently ventilated place. It may result in electric shock, fire and/or malfunction.
-  Do not install in an unstable or vibrating position. It may result in electric shock, fire and/or malfunction when/if the product falls to the ground.
-  Do not install the product in proximity to a source of heat and humidity such as a heater or a stove. Avoid placing the unit in direct sunlight.
-  Be cautious of a dew formation. Please completely dry the product before use when it happens.

■ About transceiver

-  Be cautious of the whip antenna when carried in your shirt-pocket etc. It may make contact with your eye and cause injury.
-  Do not connect devices other than specified ones to the jacks and ports on the product. It may result in damage to the devices.
-  Turn off and remove the power source (AC cable, DC cable, battery, cigar cable, charger adapter etc.) from the product when the product is not in use for extended period of time or in case of maintenance.
-  Never pull the cord alone when you unplug AC cable from the wall outlet.
-  Use a clean, dry cloth to wipe off dirt and condensation from the surface of the product. Never use thinner or benzene for cleaning.

■ About power supply

-  Use only reliable power supply of specific DC output range and be mindful of the polarity of the cable and DC-jack.
-  Always turn off the power supply when connecting or disconnecting the cables.
-  When using an external antenna, make sure that the antenna ground is not common with the ground of the power supply.
-  When a unit is powered from an external DC power source (adapter, power supply, cigar-plug etc), please make sure that such external DC power source shall be a limited power source per IEC/EN 60950-1.

■ Lightning

Any person is not safe outdoor during thunderstorm and lightning. This condition is getting worse if somebody keeps a hand-held radio; chances of being hit by lightning are doubled since lightning may hit a radio antenna as well. At this time, there is no hand-held radio having any kind of protection against lightning current (which is higher than 10 kA.). Note also that no car provides adequate protection of its passengers or drivers against lightning as well. Therefore, Alinco will not take responsibility for any danger associated with using its hand-held radios outdoor or inside the car during lightning.

■ Limited Power Source

Adhering to the requirement of the following warning ensures compliance of the transceiver with the safety standard for information technology equipment, EN 60950-1. Please note that the transceiver enclosure only provides mechanical protection of its internal parts; it will not contain a fire within the device if the fire starts under certain fault conditions. Alinco will not take responsibility for any fire hazard associated with powering the transceiver or charging its batteries using a power source which does not belong to the limited power sources in the meaning of EN 60950-1. Excluded from possible use with the transceiver are most car cigarette lighters and some DC (AC/DC) power supplies. Make sure that the power supply used with the transceiver is a limited power source.

■ Water-proof

The IEC 60529/IPX7 is an European system of test specification standards for classifying the degrees of protection provided by the enclosures of electrical equipment. An IPX7 designation means that the unit withstands immersion in one meter (approx 3ft) of still water for up to 30 minutes.

The factory guarantees this grade for 1 year provided all the jack covers are properly and securely closed. However, please understand that this unit is NOT an IPX7 COMPLIANT, but compatible; we have tested and approved at our engineering stage that this product meets the requirement of IPX7 but we do not test it unit-by-unit at the factory before delivery. Please understand that water-pressure such as washing the unit with running water may cause damage to the unit and voids warranty. Never immerse the unit uselessly under the water (V/UHF signal does not propagate in water at all). If the unit is dropped in water, please pick it up immediately and wipe with a clean dry cloth. Use only specified water-proof accessories when the unit is intended for use in rainy/wet conditions.

Introduction

Thank you very much for purchasing this excellent Alinco transceiver. Our products are ranked among the finest in the world. This radio has been manufactured with state of the art technology and it has been tested carefully at our factory. It is designed to operate to your satisfaction for many years under normal use.

PLEASE READ THIS MANUAL COMPLETELY TO LEARN ALL THE FUNCTIONS THE PRODUCT OFFERS. WE MADE EVERY ATTEMPT TO WRITE THIS MANUAL TO BE AS COMPREHENSIVE AND EASY TO UNDERSTAND AS POSSIBLE. IT IS IMPORTANT TO NOTE THAT SOME OF THE OPERATIONS MAY BE EXPLAINED IN RELATION TO INFORMATION IN PREVIOUS CHAPTERS. BY READING JUST ONE PART OF THE MANUAL, YOU RISK NOT UNDERSTANDING THE COMPLETE EXPLANATION OF THE FUNCTION.

Contents

NOTICE / Compliance Information Statement	3
Warning	4
Introduction	9
Contents	10
1.Features	13
1.1 Accessories.....	13
2.Accessories	14
2.1 Installations.....	14
2.1.1 Antenna.....	14
2.1.2 Hand Strap.....	14
2.1.3 Belt Clip.....	14
2.1.4 Battery Pack.....	15
2.1.5 Prevent Short Circuiting the Battery Pack.....	17
2.1.6 Dry Cell Case (optional).....	18
2.1.7 Battery-Level Icon.....	19
3.Names and Operations of Parts	20
3.1 Names and Operations of Keys and Ports.....	20
3.2 Keypad.....	22
3.3 Display (LCD).....	23
4.Basic Operation	24
4.1 Turning On the Power.....	24
4.2 Adjusting the Audio Output (Volume).....	24
4.3 Adjusting the Squelch.....	25
4.4 Setting the Frequency in the VFO Mode.....	25
4.4.1 Setting the Frequency.....	25
4.4.2 Setting the Tuning Step.....	25
4.4.3 Shift Direction and Offset Frequency Settings.....	26
4.5 Memory Mode.....	27
4.5.1 How to Program Memory Channel(s).....	27
4.5.2 Recalling a Memory Channel.....	28
4.5.3 Deleting a Memory Channel.....	28
4.5.4 How to Program Call Channel.....	28
4.5.5 Programming a Repeater-Access Function Setting.....	28
4.5.6 Programmable Parameters in Memory Channels.....	29
4.6 Call-Channel Mode.....	30

4.7	Receiving	30
4.7.1	Monitor Function	30
4.8	Transmitting	31
4.8.1	Selecting the Output Level	31
5.	Useful Functions	32
5.1	Scan Modes	32
5.1.1	VFO-Scan	32
5.1.2	Memory-Scan	32
5.1.3	Setting Skip Channels	33
5.2	Keylock	33
5.3	Tone-Burst	33
5.4	Naming Memory Channels	34
5.4.1	Setting Name-Tag	34
5.4.2	Using the Channel Name Function	34
5.5	Auto-Power-Off (APO)	35
5.5.1	Setting APO	35
5.5.2	APO Operation	35
5.6	Time-Out-Timer (TOT)	35
5.6.1	Setting TOT	35
5.6.2	TOT Operation	35
5.7	Lamp	36
6.	Selective Calling	37
■	Selective Calling Operations	37
6.1	Tone Squelch (TSQ)	37
6.1.1	Setting the Tone Squelch	37
6.1.2	Setting the Tone Frequency	37
6.1.3	Switching Off the Tone Squelch	38
6.1.4	To Differentiate the ENC/DEC Tones	38
6.1.5	Tone Squelch Operation	38
6.2	DCS	38
6.2.1	Setting the DCS	38
6.2.2	Changing the DCS Code	39
6.2.3	Switching Off DCS	39
6.2.4	DCS Operation	39
7.	Special Functions	40
7.1	ATT (Attenuator)	40
7.2	Battery Refresh	40
7.3	Repeater-Access	41

8.Set Mode.....	42
8.1 Set Mode Operation	42
8.2 Entering the Set Mode	43
8.3 Available Parameters	43
8.3.1 Menu 1 Battery Save (BS) Function	43
8.3.2 Menu 2 Timer/Busy Scan Setting	43
8.3.3 Menu 3 Beep Function	44
8.3.4 Menu 4 Tone-Burst Frequency Setting	44
8.3.5 Menu 5 Clock Shift Setting	44
8.3.6 Menu 6 Busy Channel Lockout Setting	45
8.3.7 Menu 7 TOT (Time-Out-Timer) Setting	45
8.3.8 Menu 8 TOT Penalty Time	45
8.3.9 Menu 9 Tuning Step Setting	45
8.3.10 Menu 10 Shift Direction Setting	45
8.3.11 Menu 11 Offset Frequency Setting	45
8.3.12 Menu 12 Tone Squelch Setting	46
8.3.13 Menu 13 Tone Frequency Setting	46
8.3.14 Menu 14 DCS Setting.....	46
8.3.15 Menu 15 APO (Auto-Power-Off) Setting	46
8.3.16 Menu 16 Skip Channel Setting.....	46
8.3.17 Menu 17 ATT (Attenuator) Setting.....	46
8.3.18 Menu 18 Battery Charge Function	46
8.3.19 Menu 19 Battery Type Setting	47
9.Cloning and Packet Operation	48
9.1 Cloning.....	48
9.1.1 Cable Connection	48
9.1.2 Master/Slave Units	48
9.1.3 Master Unit Operation.....	49
9.1.4 Slave Unit Operation	49
9.2 Packet Operation.....	50
9.2.1 Packet Operation Connections	50
10.Maintenance and Reference.....	51
10.1 Troubleshooting	51
10.2 Resetting	52
10.3 Options.....	53
10.3.1 Microphone/Speaker Cable (EDS-10).....	54
10.3.2 Battery Packs.....	54
10.3.3 Using the Chargers	55
11.Specifications	61

1. Features

This transceiver has the following main features.

- High-grade waterproof compatible to IPX7* (submersible 1m/3feet for 30min.) and rugged body
- 39 CTCSS tone squelch
- 104 DCS digital code squelch
- Time-Out-Timer
- Alphanumeric display
- 4 tone-burst tones (1750, 2100, 1000, 1450Hz)
- A quick "Repeater-Access" function
- Refresh function for rechargeable battery reconditioning
- Cable Cloning

* Please read page 8 for more details.

1.1 Accessories

- Ni-MH battery pack EBP-65 (7.2V 700mAh)
- EDC-147 (AC 230V) wall charger (E/TFH version)/EDC-148 (U.K. models)
- Flexible whip antenna EA0141 (DJ-S17E version)
- Flexible whip antenna EA0142 (DJ-S17TFH version)
- Flexible whip antenna EA0143 (DJ-S47E version)
- Belt clip
- Hand strap
- Instruction manual

* Accessories may differ depending on the version you have purchased.

Please contact your local dealer for details of standard accessories and the warranty-policy before purchase.

2. Accessories

2.1 Installations

2.1.1 Antenna

■ Attaching the Antenna

1. Hold the antenna by its base.
2. Align the grooves at the base of the antenna with the protrusions on the antenna connector.
3. Slide the antenna down and turn it clockwise until it stops.
4. Confirm that the antenna is securely connected.

NOTE:

This antenna has been designed very flexible. It is softer than conventional ones but not a defect.

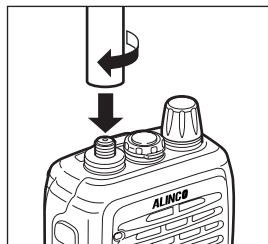

■ Removing the Antenna

Turn the antenna counter-clockwise to disconnect the antenna.

2.1.2 Hand Strap

Attach the hand strap as shown. There are two ways to attach it.

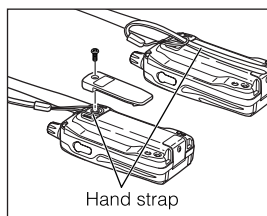

2.1.3 Belt Clip

■ Attaching the Belt Clip

1. Put the belt clip on the back of the unit, and turn the screw clockwise until it stops.
2. Confirm that the belt clip is securely attached.

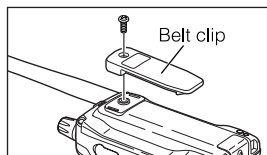

■ Removing the Belt Clip

Turn the screw counter-clockwise to remove the belt clip.

2.1.4 Battery Pack

For the specifications and the charging procedures, please refer to "Battery Packs"(page 54) and "Using the Chargers"(page 55).

■ Attaching the Battery Pack

Align the catches on the battery pack with the grooves on the unit, and close the latch until it clicks.

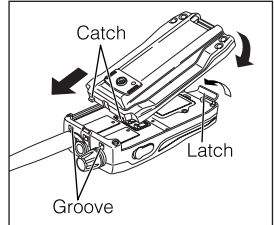

■ Removing the Battery Pack

Push the latch in the direction of the arrow, and pull out the battery pack.

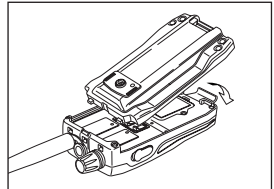

Caution

- The battery pack isn't fully charged when shipped. It must be charged before use.
- Charging should be conducted in a temperature range of 0°C to +40°C (+32°F to +104°F).
- Don't modify, dismantle, incinerate or immerse the battery pack in the water as this can be dangerous.
- Never short-circuit the battery pack terminals, as this can cause damage to the equipment or lead to heating of the battery which may cause burns.
- Unnecessary prolonged charging (overcharging) can deteriorate battery performance.
- The battery pack should be stored in a dry place where temperature is in -10°C to +45°C (-14°F to +113°F) range. Temperatures outside this range can cause the battery liquid to leak. Exposure to prolonged high humidity can cause corrosion of metal components.
- Battery-packs are a consuming part. When its operating time becomes considerably short after a normal charge, please consider that the pack is exhausted and replace it with a new one.
- The battery pack is recyclable. Check with your local waste officials for details on recycling options or proper disposal in your area.



Caution

- Li-ion battery packs can't be charged using DC-jack on the unit (Only Ni-MH battery packs can be charged).
- Risk of explosion, generation of heat or leak of chemicals inside if the battery is replaced by an incorrect type. Use always the recommended types of batteries in this manual only.

■ Charging the Battery Pack Using DC-Jack on the Unit

The unit can charge the EBP-65 and EBP-66 optional Ni-MH battery packs by supplying DC power through the DC-jack on the unit using EDC-147/148 wall chargers or an optional DC power supply (DC 12V~DC 16V, 1A or more: IEC/EN 60950-1 compliant) and a DC cable such as EDC-37.

1. Attach the battery pack by referring to "Battery Pack" (page 15).

2. Connect the AC adapter plug to the DC-jack on the unit then connect the charger's adapter to the wall outlet.

* AC adapter may look different.

3. Turn on the unit and set the battery charge parameters. Please refer to "Set Mode" (page 42) then:

* "Battery Charge Function" (page 46)

Select CHG-ON.

* "Battery Type Setting" (page 47)

Select BAT-NI.

4. After completing the settings, a flashing  appears on the display. Make sure the icon is flashing then turn off the unit. It takes about 10 hours/30hours for EBP-65/66 respectively to complete the charge.

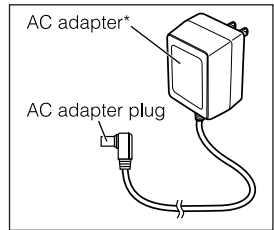

IMPORTANT NOTE:

While this function is activated, without attaching a battery pack or the remaining battery level is below the usable range, the unit turns on by just connecting the DC source such as an adapter or a DC cable (without operating the power key).

NOTE:

- Please read the general safety instructions included in the optional accessories to correctly and safely use them.
- EDC-147/148 can't be used as the adapter for operation. These adapters are for charging purposes only.
- Chargers can't perform the correct charge when the AC voltage is unstable.
-  flashes even EBP-65/66 aren't attached. To avoid short-circuit, never activate this function when the pack isn't attached to the unit.
- Li-ion battery packs can't be charged in this way.

2.1.5 Prevent Short Circuiting the Battery Pack

Be extra cautious when carrying the rechargeable battery pack; short circuiting will produce surge current possibly resulting in fire.

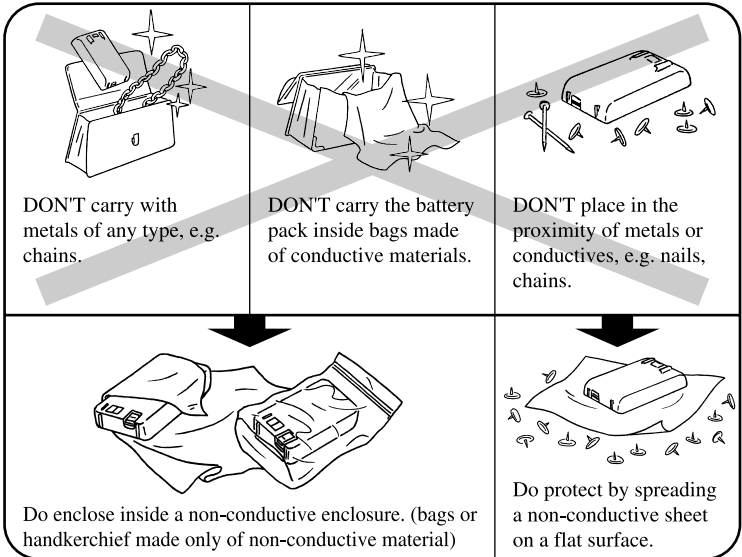

2.1.6 Dry Cell Case (optional)

An EDH-34 is available for operation with using AA cells.

Lift up the catches ① on the top of the case to remove the cover.

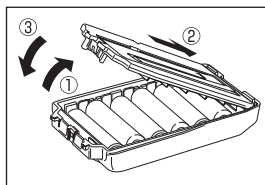

Place 6 AA cells, then close the cover in order of ② then ③. Be sure that the cover is securely closed.

Use high-performance AA cells such as Alkaline or Oxiride cells.

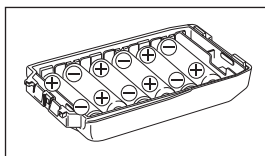

Caution About Handling Dry Cell Case:

- This dry cell case isn't water-proof.
- Be extra-cautious to the polarity of the cells (+)/(-). Misplacing cells may result in leak, fire or explosion.
- Use new batteries of the same type and brand when placing them.
- Use of rechargeable cells is prohibited and the manufacturer declines any responsibilities for damages/injuries that may cause to the users and their properties.
- It is recommended to clean the battery contacting terminals with a clean dry cloth from time to time.
- Risk of explosion if batteries are replaced by an incorrect type.
- Batteries are recyclable. Please check the local rules for proper recycle/disposal in your area.



Caution About Battery Charge Function:



The battery charge function is on by default. With this function on and the dry cells installed, connecting the provided EDC-147/148 AC adapter or an optional external power supply(stabilized power supply, cigarette lighter cable, etc.) to the DC-jack on the unit may send current through the dry cells, resulting in battery leak, heat or explosion. Referring to "Menu 18 Battery Charge Function" on page 46, be sure to set this function off (select CHG-OFF) when the unit is equipped with the dry cells. However, there is no danger even if CHG-ON is selected as long as no external power supply is connected to the unit.

2.1.7 Battery-Level Icon

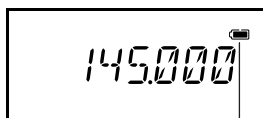
During the operation, a black battery icon indicates that the battery-level is in usable range. When it turns to empty, please charge the pack or replace the cells with new ones.



Battery-level icon

-  The battery is in usable condition.
-  Battery-level is low.
Replace or charge the pack.

3. Names and Operations of Parts

3.1 Names and Operations of Keys and Ports

■ Top and Front

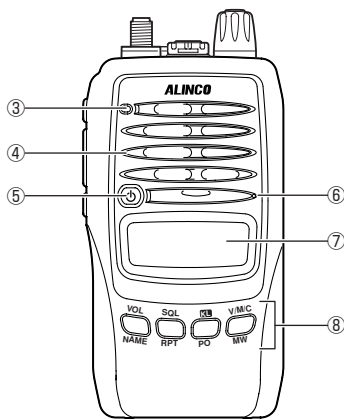
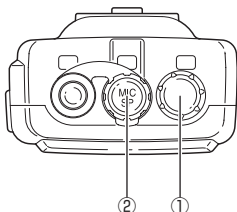

①	Dial	Rotate the dial to select the frequency of operation, memory channel, offset frequency, tone frequency, DCS code, Set mode settings, and the characters for name-tags. Rotating the dial while pressing the FUNC key increases or decreases the frequency in 1MHz order.
②	Microphone/ Speaker jack	For an optional speaker/Mic connection. Securely close the cover for water-proof while the accessory isn't in use.
③	TX/RX lamp	Lights green when the squelch is unmuted. Lights red during transmission.
④	Speaker	A speaker is built in.
⑤	Power key	Press the power key down for approximately one second to turn on/off the unit.
⑥	Microphone	Speak into the microphone from a distance of about 5cm (2").
⑦	Display (LCD)	Refer to "Display (LCD)" (page 23).
⑧	Keypad	Refer to "Keypad" (page 22).



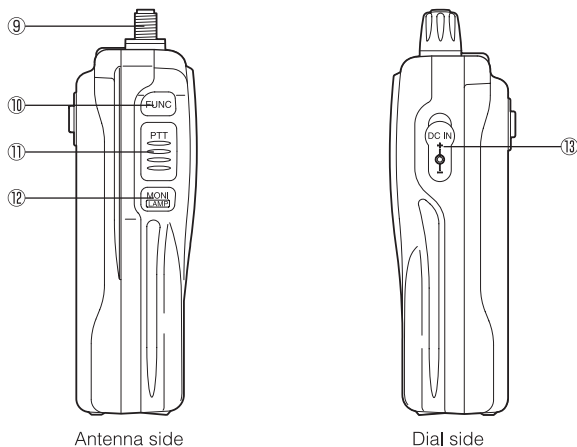

■ Side

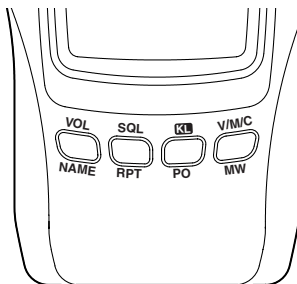

⑨	SMA Antenna Connector	Attach the whip antenna. If you plan to use an optional antenna, select one that is tuned to the operating frequency.
⑩	FUNC key	The FUNC key is used in combination with the other keys to access the various functions of the unit. To enter the Set mode to set operating parameters, press the FUNC key continuously for about 2 seconds.
⑪	PTT key	Press the PTT key to transmit, release to receive.
⑫	MONI key	When the MONI key is pressed, the squelch unmutes regardless of the TSQ/DCS setting. Pressing the MONI key after pressing the FUNC key illuminates display for about 5 seconds. Pressing the MONI key while pressing the PTT key transmits a tone-burst signal.
⑬	DC-IN jack	Connect an external power source of DC 7.0V~DC 16.0V at 2A or more. An optional EDC-36 cigar-cable is available for mobile operation. EBP-65/66 packs can be charged using this jack (page 16).

3.2 Keypad



key	Without pressing the FUNC key.	While F appears after the FUNC key is pressed.
	Audio level adjustment (page 24).	Naming memory channels setting (page 34).
	SQL adjustment (page 25). Start scanning (page 32).	Repeater-Access function setting (page 41).
	Key lock setting (page 33).	Hi / Low power setting (page 31).
	Switches between the VFO / Memory / Call channel mode (page 25).	Memory programming (page 27).

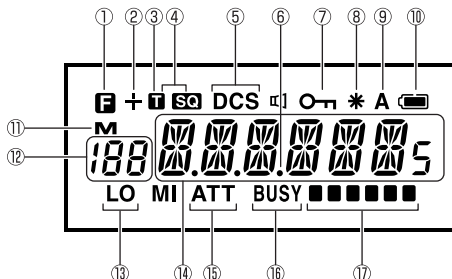

3.3 Display (LCD)



①	F	Appears when the FUNC key is pressed.
②	+	Indicates the shift (+/-) direction.
③	T	Appears when setting the CTCSS tone encoder.
④	T SQ	Appears when setting the tone squelch.
⑤	DCS	Appears when setting the DCS.
⑥	•	Displays the frequency and scan operation.
⑦	LOCK	Displayed when the frequency or the keypad is locked.
⑧	*	Appears when the Repeater-Access function is activated.
⑨	A	Appears when Auto-Power-Off function is activated.
⑩		Indicates battery-level. The black icon flashes when the battery charge function is on.
⑪	M	Displayed when in the Memory mode.
⑫	188	Displays the memory channel No.
⑬	LO	Displayed when the transmission output is in LOW setting.
⑭		Displays the operating frequencies, name-tags and parameters in the setting mode.
⑮	ATT	Appears when the attenuator is activated.
⑯	BUSY	Appears when the squelch is unmuted.
⑰		Indicates the receiving signal (S-meter) and transmission output levels (Power-meter).

4. Basic Operation

4.1 Turning On the Power

Hold the  key down for a second. To turn off the power, hold the  key down until the display turns off.

default frequencies

<DJ-S17>

E



TFH



<DJ-S47>

E



NOTE:

This manual has been edited based on DJ-S17E.

Frequency display may vary depending on the model you have purchased.

4.2 Adjusting the Audio Output (Volume)

- There are 21 audio output levels (00~20).
- The default setting is level 00. There is no audio output at this status.

1. Press the  key. The level is displayed on the LCD.
2. Rotate the dial to increase or decrease the level. As the setting value increases, the audio becomes louder.



3. Press any key except for the MONI key or just leave it for 5 seconds to automatically complete the setting.

3. Press any key except for the MONI or FUNC key to complete setting.

NOTE:

- Refer to "Set Mode Operation" on page 42 for the list of parameters that can be programmed in the Set mode and "Entering the Set Mode" on page 43 to enter the Set mode.
- Tuning step can't be changed in the Memory mode.
- When the tuning step is changed from 5kHz,10kHz,15kHz,20kHz or 30kHz to 12.5kHz and 25kHz or vice versa, the operating frequency and the shift width automatically suit to the new setting.

4.4.3 Shift Direction and Offset Frequency Settings

In conventional repeater systems, a signal received on one frequency is retransmitted on another frequency. The difference between these two frequencies is called the offset frequency. The selectable offset frequency of this unit is from 0 to 99.995MHz. The TX frequency can be shifted in the plus or minus direction based on the RX frequency when the PTT key is pressed. This direction is called the shift direction. You can set the shift direction and offset frequency in the Set mode. Refer to "Set Mode Operation" on page 42 and "Entering the Set Mode" on page 43. To operate the Repeater-Access function, use the Repeater-Access function memory. Refer to "Programming a Repeater-Access Function Setting" on page 28.

■ Setting the Shift Direction

1. Select the menu 10 in the Set mode to display the current shift direction setting.
2. Rotate the dial to select the desired shift direction.
 - A (-) means that the TX frequency is lower than the RX frequency.
 - A (+) means vice versa.

SFD-OF → SFD- - → SFD- +

3. Press any key except for the MONI or FUNC key to complete setting.

**Caution**

Select "SFD-OF" to cancel the shift setting.

■ Setting the Offset Frequency

1. Select the menu 11 in the Set mode to display the current offset frequency.
2. Rotate the dial to increase or decrease the frequency.
 - Clockwise: each click increases the frequency by one tuning step.
 - Counter-clockwise: each click decreases the frequency by one tuning step.
 Rotate the dial while holding down the  key to increase or decrease the frequency in 1MHz steps.
3. Press any key except for the MONI or FUNC key to complete setting.

NOTE:











- Please refer to "Selective Calling" (page 37) to set the CTCSS/DCS tones usually required for conventional Repeater-Accesses.
- If the offset frequency is set to exceed the transmitting frequency range of this unit, "OFF" appears on the display and a beep sounds when the PTT key is pressed. You can not transmit in this state.

4

4.5 Memory Mode

This mode allows recalling and operating the preprogrammed frequency or setting in the memory channels. This unit provides up to 200 memory channels, 1 CALL channel and 1 Repeater-Access function memory.





4.5.1 How to Program Memory Channel(s)

1. Select a frequency and operating parameters to be programmed in the VFO mode. Refer to "Programmable Parameters in Memory Channels" on page 29 for the list of parameters that can be programmed in the Memory mode.
2. Select the Memory mode by pressing the  key. In the Memory mode, **M**, memory channels,  or      appear on the display.
3. Press the FUNC key to display **F**.
4. Rotate the main dial to select the desired memory channel number (0 to 199) while **F** is displayed. An empty channel is shown with a flashing "**M**".
5. By pressing the  key again while **F** is on the display, a beep sounds and programming is completed. If **F** disappeared before pressing the  key, press the FUNC key again and then  key.

4.5.2 Recalling a Memory Channel

1. Select the Memory mode by pressing the  key. "M" and channel number appear on the display to indicate that the unit is in the Memory mode. Repeat to switch between the Memory, Call channel and VFO modes.
2. Select a memory channel.
Rotating the main dial will increase or decrease a memory channel number.





4.5.3 Deleting a Memory Channel

1. Select the Memory mode by pressing the  key.
2. Rotate the dial to select the memory channel No. that you wish to delete.
3. Press the FUNC key, and while **F** is displayed on the LCD, press the  key. A beep sounds, then "M" flashes on the display. If **F** disappeared before pressing the  key, press the FUNC key again and then  key.

NOTE:

When "M" is flashing in step 3 (when the memory contents are displayed as is on the display), it is still possible to cancel the operation by pressing the FUNC key, and while **F** is displayed on the LCD, press the  key. After changing channels or modes, this is no longer possible.

4.5.4 How to Program Call Channel

1. Select the Memory mode by pressing the  key. "M" appears on the display.
2. Rotate the dial to display "C".
3. Press the  key twice to switch to the VFO mode, and rotate the dial to select the desired frequency and set other parameters.
4. Press the FUNC key and while **F** is displayed, press the  key. A beep sounds and programming is completed. If **F** disappeared before pressing the  key, press the FUNC key again and then  key.

4.5.5 Programming a Repeater-Access Function Setting

The "Repeater-Access" function is to set the desired shift and tone parameters to the current operating frequency by just 2 key-touches. Parameters programmed in the Repeater-Access function memory can be used in any of the VFO/Memory/Call channel modes.

Although parameters programmed in the Set mode are maintained at any frequency, those programmed in the Repeater-Access function memory are applied to the operating frequency only by using the Repeater-Access function (page 41). Thus, it is recommended that you use this function in amateur radio where you communicate by frequently switching between simplex and semi-duplex operations.

1. Select the Memory mode by pressing the $\frac{V/M/C}{MW}$ key, then rotate the dial to select $\overline{r}p\ AL\ L\ F\ R\ Q$.
2. The $-$ (minus) and \blacksquare icons appear on the display. By default, the values are:
 DJ-S17E/TFH: minus shift, 0.6MHz offset, 88.5Hz CTCSS tone
 DJ-S47E: minus shift, 7.6MHz offset, 88.5Hz tone
 If these are the values you desire, no further setting is required so simply press the $\frac{V/M/C}{MW}$ key to go back to the operation mode. Refer to "Repeater-Access" on page 41 for operation.
3. To change the values instead, repeat the same setting sequence explained on page 26 for shift direction and offset frequency then page 37 for CTCSS tone by entering to the Set mode while $\overline{r}p\ AL\ L\ F\ R\ Q$ is displayed. Even if you desire the same values you set for the respective parameters in the VFO mode, please repeat the sequence in here to activate the Repeater-Access function.
4. After having completed the programming in the Set mode, return to the $\overline{r}p\ AL\ L\ F\ R\ Q$ menu by pressing any key except FUNC or MONI. Press the FUNC key and while \blacksquare is displayed, press the $\frac{V/M/C}{MW}$ key. A beep sounds and the new values are stored in the $\overline{r}p\ AL\ L\ F\ R\ Q$ memory.

NOTE:

- You can not communicate in the $\overline{r}p\ AL\ L\ F\ R\ Q$ channel.
- The $\overline{r}p\ AL\ L\ F\ R\ Q$ channel is skipped during scanning. You can not delete or convert this memory to other purposes.

4.5.6 Programmable Parameters in Memory Channels

The following parameters can be stored in each of the memory channels.



- Frequency
- Skip channel setting
- Busy channel lockout (BCLO)
- Transmission power (H/L)
- Battery save setting
- Clock Shift setting
- Alphanumeric channel tag
- Attenuator Level
- Offset frequency *
- Shift direction (+/-) *
- Tone encoder frequency *
- Tone decoder frequency *
- Tone encoder/decoder setting (TSQ) *
- DCS code *
- DCS setting *

NOTE:

Only parameters marked "*" are programmable in Repeater-Access function memory.

4.6 Call-Channel Mode

This mode is used to recall a most frequently used memory channel (stored in MC channel) with a single key-touch.

1. Press the  key.
"C" is displayed on the LCD, and the channel programmed in MC is recalled.
2. Press the  key again in the Call mode to return to original operating mode (VFO/memory).





NOTE:

Refer to "How to Program Call Channel" on page 28 for programming Call channel.

IMPORTANT NOTE:

- The dial operation of frequency/memory channel is blocked in the Call mode.
- It is possible to temporary change the offset and CTCSS/DCS related parameters in the Call mode by entering to the Set mode in the Call channel.
- The Scan function is deactivated in the Call mode.
- The CALL channel reprogramming is possible but it can't be deleted from the memory channel mode.

4.7 Receiving

1. Turn on the unit.
2. Press the  key and rotate the dial to adjust the audio level as necessary.
3. Press the  key and rotate the dial to adjust the squelch level.
4. Select the frequency that you wish to operate by using the dial. When a signal is received on the frequency that you selected, **BUSY** and S-meter are displayed on the LCD, then the received signal can be heard. The green RX indicator also lights at this time.

4.7.1 Monitor Function

In case the receiving signal is weak and the audio is intermittently cut off by the squelch, press the MONI key. As long as this key is pressed, the squelch including TSQ/DCS unmutes making the audio easier to hear.

- The squelch is unmuted while the MONI key is pressed, regardless of the squelch level setting.
- This function unmutes the squelch even if the DCS and Tone Squelch functions are set.

4.8 Transmitting

1. Select the frequency that you wish by using the dial.
2. Press the PTT key.
The red TX indicator turns on while transmitting.
3. While holding down the PTT key, speak into the unit at normal voice from the distance of 5cm (2").
4. Release the PTT key to receive.

IMPORTANT NOTE:

- To transmit a tone-burst signal, press the MONI key while holding down the PTT key.
- Speaking too loud, too close or too far from the unit may distort the audio.
- This unit is equipped with a special kind of cloth over the built-in microphone for water proof. For this reason, a slight change of tone may happen when you use accessories like external microphones, but this is not abnormal.
- "OFF" appears on the display and a beep sounds when the PTT key is pressed with the TX frequency set out of the TX range. You can not transmit in this state.



4

4.8.1 Selecting the Output Level

Press the FUNC key, and while **F** is displayed on the LCD, press the  key to switch between high and low transmission power output.

When the low power output is selected, "**LO**" is displayed on the LCD (nothing is displayed when the high power is selected).

The initial setting is low power.

The Power-meter display is  when transmitting at the low power, and  when transmitting at the high power.

IMPORTANT NOTE:

The output level can't be altered while transmitting.

5. Useful Functions

5.1 Scan Modes

The scan function automatically searches the receiving signals. There are 2 modes for scan-resume condition.

- **Timer Scan** : The scan stops when a signal is detected, and resumes scanning after 5 (default) seconds regardless of receiving status.
- **Busy Scan** : The scan stops when a signal is detected, stays until the signal is gone then resumes scanning.

During scanning, the 1MHz decimal point (•) on the frequency display flashes.



Press any key other than the MONI key to stop scanning.

Scanning starts in the direction of the last dial operation (up or down).



NOTE:

Please refer to the Set mode to switch the setting between Timer and Busy scan modes (page 43).

5.1.1 VFO-Scan

1. Press the  key to select the VFO mode.
2. Press the  key for more than 2 seconds to start scanning. The unit scans in accordance with the order of one step.
3. Rotate the dial clockwise/counter-clockwise to change the scan direction.
VFO-scan scans the entire frequency range.
4. Press any key other than the MONI key to stop scanning.

5.1.2 Memory-Scan

1. Press the  key to select the Memory mode.
2. Press the  key for more than 2 seconds to start memory scanning.
3. Rotate the dial clockwise/counter-clockwise to change the scan direction.
Memory-scan scans all programmed memory channels.
4. Press any key other than the MONI key to stop scanning.

NOTE:

Please set the squelch level correctly before scanning, even in the TSQ scanning the normal squelch level adjustment is required to activate this function.

5.1.3 Setting Skip Channels

You can select the memory channels that you wish to skip during the memory-scan.

1. Select the memory channel in the Memory mode that you wish to skip.
2. Press the FUNC key for more than 2 seconds to enter the Set mode, and select the menu 16 to display the current skip channel setting.
3. Rotate the dial to switch between ON and OFF. Select ON to set the memory channel as a skip channel.
4. The 10MHz decimal point appears for the memory channel that is set as a skip channel.

NOTE:

The Call channel and Repeater-Access memory are automatically skipped during scanning.

5.2 Keylock

Press the  key for more than 2 seconds to set the Keylock function on, and repeat the same to quit.

When the Keylock is on, the  is displayed on the LCD.

When the Keylock is on, other than the following, all operations are blocked.

- * PTT
- * LAMP
- * MONI
- * VOL
- * SQL
- * Tone-burst
- * POWER ON/OFF

NOTE:

Keylock function can't be activated on the Repeater-Access function memory channel.

5.3 Tone-Burst





This function is to generate an audible tone to access repeaters mostly used in Europe.

- To output the tone-burst tone, press the MONI key while holding down the PTT key. The tone is transmitted as long as the MONI key is pressed. The initial setting for the tone-burst tone is 1750Hz, but this can be changed in the Set mode (page 44).
- While transmitting the tone-burst tone, the CTCSS/DCS tone is temporary suspended.
- Even while transmitting the tone-burst tone, you can not hear audio from the speaker.

5.4 Naming Memory Channels

In the Memory mode, it is possible to display up to 6 alphanumeric characters (Name-tag) instead of conventional frequency display.

5.4.1 Setting Name-Tag

1. Select the memory channel.
2. Press the FUNC key, and while **F** is displayed press the  key.
3. [A] flashes on the display.
4. Rotate the dial to select a character to be the first digit.
5. Press the  key to input the next character. The previous character will stop flashing.
6. Repeat the same sequence as necessary.
Press the  key during setting to delete all characters.
7. Press any key (except MONI, , ) to complete the setting.

NOTE:

Only lighted characters (not flashing ones) are programmed. For example, to program 3 characters, complete the setting when the fourth character is flashing. To program 6 characters, complete the setting after the first character goes back to the flashing status.

5.4.2 Using the Channel Name Function

- Programmed memory channels are displayed with alphanumeric characters. The channel number is displayed as it normally is.
- Press the FUNC key to display the frequency display for 5 seconds. Pressing certain keys during this 5 sec period may immediately recall the alphanumeric display, while other keys access their allocated functions.

5.5 Auto-Power-Off (APO)

This function prevents an useless battery consumption.

5.5.1 Setting APO

1. Select the menu 15 in the Set mode to display the current APO setting.
2. Rotate the dial to switch between ON and OFF.
3. Selecting ON activates the APO function, and **A** is displayed on the LCD.
 - The initial setting for the APO function is off.

5.5.2 APO Operation

- After having activated the APO and about 30 minutes elapse without any key-operation, the unit turns off automatically alerting with beep sounds. The time to Auto-Power-Off is determined by the last key operation only, not the last signal received.

5.6 Time-Out-Timer (TOT)

This function automatically stops transmission when a preset time is elapsed.

5.6.1 Setting TOT

1. Select the menu 07 in the Set mode to display the current TOT setting. T-OFF is displayed by default.
2. Rotate the dial to change the TOT setting time.
The maximum setting for the TOT time is 450 seconds.

OFF → 30 → 60 → 90 → ----- → 450 (unit: seconds)

3. Press any key other than the MONI or FUNC key to complete the setting.

5.6.2 TOT Operation

When the preset time is about to be elapsed, a beep sounds to alert that the unit is forced to quit transmitting. Release PTT key to quit transmitting otherwise the TOT penalty may be activated. Refer to page 45 for TOT penalty time setting.

5.7 Lamp

Press the FUNC key, and while **F** is displayed on the LCD, press the MONI key to illuminate the display and keypad.

- The backlight automatically switches off if there is no key operation for 5 seconds.
- Pressing any key other than the LAMP key extends the LAMP function for another 5 seconds.
- Turning on the power while pressing the MONI key illuminates the backlight permanently. Repeat the same to turn it off.
- When the lamp is set for the "permanent-on" position, pressing the FUNC key then the MONI key to turn on/off the backlight.

NOTE:

The LAMP function consumes battery. The "permanent-on" position is recommended only for the operation using an external power source.

6. Selective Calling

■ Selective Calling Operations

- To communicate only with selected stations, use either the Tone Squelch or the DCS function.
- The Tone Squelch function unmutes the squelch only when a signal added with one of the matching 39 CTCSS tone frequencies is received.
- The DCS function unmutes the squelch only when a signal added with one of matching 104 digital codes is received.
- It isn't possible to use the Tone Squelch and DCS functions at the same time.

6.1 Tone Squelch (TSQ)

6.1.1 Setting the Tone Squelch

1. Select the menu 12 in the Set mode to display the current TSQ setting.
2. Rotating the dial, the display changes as below:

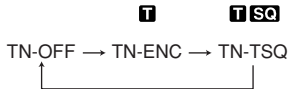

- When only **T** is displayed, the unit encodes the CTCSS tone.
 - When **T SQ** is displayed, the unit encodes and decodes the CTCSS tone.
3. Press any key other than the MONI or FUNC key to complete setting.

6.1.2 Setting the Tone Frequency

1. Select the menu 13 in the Set mode to display the current tone frequency.
2. Rotate the dial to select one of the 39 CTCSS tones shown below. The tone can be set for encode/decode separately (refer to page 38 for details).

										(unit: Hz)
67.0	69.3	71.9	74.4	77.0	79.7	82.5	85.4	88.5	91.5	
94.8	97.4	100.0	103.5	107.2	110.9	114.8	118.8	123.0	127.3	
131.8	136.5	141.3	146.2	151.4	156.7	162.2	167.9	173.8	179.9	
186.2	192.8	203.5	210.7	218.1	225.7	233.6	241.8	250.3		

3. Press any key other than the MONI or FUNC key to complete the setting.
 - Observe that **T** is displayed if you selected TN-ENC in the menu 12.
 - Observe that both **T SQ** are displayed if you selected TN-TSQ in the menu 12.

6.1.3 Switching Off the Tone Squelch

Select TN-OFF in the menu 12 of the Set mode, and press any key other than the MONI or FUNC key to complete setting.

6.1.4 To Differentiate the ENC/DEC Tones

To set the encoding and decoding tones independently, perform the following settings.

1. To set the encoding tone, while **1** is displayed in the setting menu 12, press the FUNC key to move to the menu 13 and select a desired encoding tone by rotating the dial.
2. Press the MONI key to go back to the menu 12 then rotate the dial clockwise to select TN-TSQ. Press the FUNC key to move to the menu 13 again and select a desired decoding tone frequency using the dial.
3. Press the PTT key to return to the operating mode or the FUNC/MONI keys to continue with setting programming in the Set mode.

6.1.5 Tone Squelch Operation

The squelch unmutes only when the signal with the same decoding-setting tone is received.

6

6.2 DCS

6.2.1 Setting the DCS

1. Select the menu 14 in the Set mode to display the current DCS setting. The initial setting is DCS-OFF.

Rotating the dial, the display switches between:

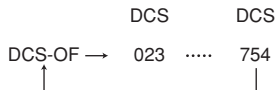

2. Press any key other than the MONI or FUNC key to complete the setting. Observe that "**DCS**" is displayed.

6.2.2 Changing the DCS Code

1. In the menu 14 of the Set mode, rotate the dial to select the desired DCS code.
2. Press any key other than the MONI or FUNC key to complete the setting.
 - The same DCS code is set for ENC/DEC, differential setting isn't available.

One of the following 104 DCS codes can be selected.

023	025	026	031	032	036	043	047	051	053
054	065	071	072	073	074	114	115	116	122
125	131	132	134	143	145	152	155	156	162
165	172	174	205	212	223	225	226	243	244
245	246	251	252	255	261	263	265	266	271
274	306	311	315	325	331	332	343	346	351
356	364	365	371	411	412	413	423	431	432
445	446	452	454	455	462	464	465	466	503
506	516	523	526	532	546	565	606	612	624
627	631	632	654	662	664	703	712	723	731
732	734	743	754						

6.2.3 Switching Off DCS

Select DCS-OFF in the menu 14 of the Set mode to turn it off.

6.2.4 DCS Operation

The squelch unmutes only when the unit receives the matching code.

7. Special Functions

7.1 ATT (Attenuator)

Use this function when the receiving signal is interfered by strong signals of nearby channels. When you activate this function, the transceiver attenuates the receiving sensitivity.

1. Select the menu 17 in the Set mode to display the current ATT setting.
2. Rotate the dial to change the ATT level. There are 2 levels; ATT-1 attenuates the received signal by 10dB and ATT-2 does 20dB. Press any key other than the MONI or FUNC key to complete setting. Observe that "**ATT**" appears on the display.

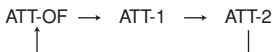

Select ATT-OF in the setting sequence, and then press MONI or FUNC key to turn off this function. Observe that "**ATT**" disappears from the display.

7.2 Battery Refresh

Repeating improper recharge of the Ni-MH battery pack may cause so-called the "memory effect" that the battery holds less charge. To avoid this, it is always recommended to fully discharge the battery pack then full charge. This function helps discharging the battery pack. Please remove the unit from a charger or a DC cable before this operation.

1. Activate the Keylock (page 33).
2. Press the FUNC key, and while **F** is displayed, press the $\frac{V/M/C}{MW}$ key twice, the $\frac{CR}{PO}$ key twice, the $\frac{SQL}{RPT}$ key twice, and then the $\frac{VOL}{NAME}$ key twice. "DISCHG" will be displayed on the LCD, and the battery-refresh starts.

DISCHG
3. To cancel this operation, just turn off the unit, turn it on again, then unlock the Keylock function.
4. The unit will turn off automatically when finished the refresh.

**Caution**

- The time to refresh totally depends on the remaining charge of the battery pack. To discharge the fully-charged EBP-65 may take up to approx. 7 hours.
- When this function is on, the backlight and the keys are illuminated, and noise from the speaker can be heard.
- Before storing the rechargeable battery pack for an extended period of time, please full-charge it after this operation. Also, refresh and fully charge the battery once every 6 months to keep the pack in good condition.

7.3 Repeater-Access

1. In the VFO/Memory/Call channel mode, select the channel to which you wish to apply the Repeater-Access setting.
2. Press the FUNC key, and while **F** is displayed on the LCD, press the  key.
The Repeater-Access setting is applied to the operating frequency.

NOTE:

Preset parameters on the Repeater-Access function memory will be effective at any frequency. Repeater-Access parameters have priorities over the parameters programmed in the VFO/memory/CALL modes.

8. Set Mode

The Set mode is used to customize the various operational parameters of your DJ-S17/47.

8.1 Set Mode Operation

This chart shows the available parameters in the Set mode.

Menu	Default setting	Function
01	BS-ON	Battery Save ON/OFF
02	TIMER	Timer/Busy scan setting
03	BEP-ON	Beep sound ON/OFF
04	1750	Tone-Burst Frequency setting
05	SFT-OF	CPU Clock Frequency shift ON/OFF
06	BCL-OF	Busy Channle Lock Out ON/OFF
07	T-OFF	TOT (Time-Out-Timer) setting
08	TP-OFF	TOT Penalty setting
09	STP-5	Tuning Step setting
10	SFD-OF	Shift Direction setting
11	0.600 (7.600)	Offset Frequency setting
12	TN-OFF	Tone Squelch setting
13	88.5	Tone Frequency setting
14	DCS-OF	DCS setting
15	APO-OF	APO (Auto-Power-Off) setting
16	SKP-OF	Skip Channel setting
17	ATT-OF	ATT (Attenuator) setting
18	CHG-ON	Battery Charge ON/OFF
19	BAT-NI	Battery type setting

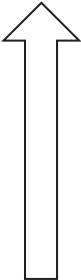
 FUNC key
 MONI key

8.2 Entering the Set Mode

1. Press the FUNC key for at least 2 seconds.
The unit enters the Set mode.
"BS-ON" is displayed as a factory-default.
2. Press the MONI key or FUNC key to select a menu.
The Monitor function can't be used in this status.
3. Rotate the dial to change the parameter.
4. Press any key other than the MONI key and FUNC key to complete the settings, or use the MONI or FUNC keys to continue programming.

The last operated menu will be selected the next time you enter the Set mode.

8.3 Available Parameters

8.3.1 Menu 1 Battery Save (BS) Function

This function prevents useless battery consumption by switching the power ON/OFF at a fixed ratio if there is no key operation or receiving signal for a continuous period of 5 seconds or more.

1. BS-ON is displayed on the LCD.
2. Rotate the dial to select the battery save setting (on or off).

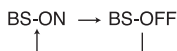

- The factory setting is BS-ON
- The Battery Save function is temporarily suspended when a key is operated or a signal is received.
- Set this parameter OFF for packet operation.
- The display remain unchanged even the BS function is in the OFF cycle.

8.3.2 Menu 2 Timer/Busy Scan Setting

Select the scan-resume condition in this menu (page 32).

1. TIMER is displayed on the LCD.
2. Rotate the dial to select the scan-resume condition between TIMER and BUSY.

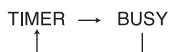

8.3.3 Menu 3 Beep Function

Select OFF to turn off all the beep sounds inclusive of alerting beeps.

1. BEP-ON is displayed on the LCD.
2. Rotate the dial to select the beep setting on and off.

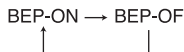

8.3.4 Menu 4 Tone-Burst Frequency Setting

1. 1750 is displayed on the LCD.
2. Rotate the dial to select the tone-burst frequency.

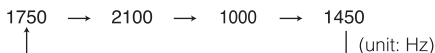

8.3.5 Menu 5 Clock Shift Setting

In the unlikely event that you may hear a weak noise always on the same frequency, it may be so-called a CPU-clock noise. Unfortunately this is due to the circuit-design of this product and can't be eliminated, but can be moved away to another frequency.

1. SFT-OFF is displayed on the LCD.
2. Rotate the dial to select the clock shift setting on and off.

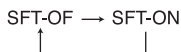

NOTE:

This function isn't a noise-blanker. Also, since not all noises are due to a CPU-clock noise, the clock shift setting may not be effective.

8.3.6 Menu 6 Busy Channel Lockout Setting

This function restricts the PTT (transmit) operation.

1. BCL-OFF is displayed on the LCD.
2. Rotate the dial to select the Busy Channel Lockout setting on and off.

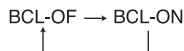

When Busy Channel Lockout is set to on, transmission is possible only in the following conditions (and isn't possible otherwise).

The alarm sounds if the PTT key is pressed when transmission is prohibited.

- 1) When no signal is being received (BUSY isn't displayed).
- 2) When the tone matches and the squelch is unmuted based on the Tone Squelch setting conditions.
- 3) When the codes match and the squelch is unmuted based on the DCS setting conditions.

8.3.7 Menu 7 TOT (Time-Out-Timer) Setting

Refer to "Time-Out-Timer (TOT)" on page 35.

8.3.8 Menu 8 TOT Penalty Time

This parameter determines the time to resume the transmission after the unit is forced to quit transmitting by TOT.

1. TP-OFF is displayed on the LCD.
2. Rotate the dial to change the TOT Penalty Time setting.

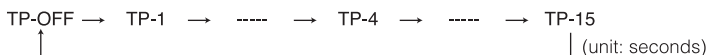

Transmission is prohibited until the penalty time elapses.

- An alert beep sounds when the PTT key is pressed during the penalty time.

8.3.9 Menu 9 Tuning Step Setting

Refer to "Setting the Tuning Step" on page 25.

8.3.10 Menu 10 Shift Direction Setting

Refer to "Shift Direction and Offset Frequency Settings" on page 26.

8.3.11 Menu 11 Offset Frequency Setting

Refer to "Shift Direction and Offset Frequency Settings" on page 26.

8.3.12 Menu 12 Tone Squelch Setting

Refer to "Setting the Tone Squelch" on page 37.

8.3.13 Menu 13 Tone Frequency Setting

Refer to "Setting the Tone Frequency" on page 37.

8.3.14 Menu 14 DCS Setting

Refer to "Setting the DCS" on page 38.

8.3.15 Menu 15 APO (Auto-Power-Off) Setting

Refer to "Setting APO" on page 35.

8.3.16 Menu 16 Skip Channel Setting

Refer to "Setting Skip Channels" on page 33.

8.3.17 Menu 17 ATT (Attenuator) Setting

Refer to "ATT (Attenuator)" on page 40.

8.3.18 Menu 18 Battery Charge Function

The Ni-MH battery pack can be charged with an external power supply or an optional AC adapter using the DC-jack on the unit. Please select ON to activate this function. The factory setting is ON.

1. CHG-ON is displayed on the LCD.
2. Rotate the dial to select the battery charge setting on and off.
3. Please be sure to read "Battery Type Setting " (page 47) to correctly use this function.

CHG-ON → CHG-OFF



Caution

- Please be sure to select OFF when using a dry cell case otherwise it may risk a leak of battery liquid, heat or explosion of the battery cells and the battery case.
- While this function is activated, without attaching a battery pack or the remaining battery level is below the usable range, the unit turns on by just connecting the DC source such as an adapter or a DC cable (without operating the power key). Therefore, leaving the battery pack detached from the unit may cause the charging terminals on the back of the unit to short out. Please be very cautious when you operate with an external DC source.

8.3.19 Menu 19 Battery Type Setting

Select the correct battery type from Ni-MH battery pack, Li-ion battery pack and Alkaline (and Oxyride) dry cells in order to display the battery-level icon correctly and to perform the battery-charge using the DC-jack.

1. BAT-NI is displayed on the LCD.
2. Rotate the dial to select battery type from Ni-MH battery pack (BAT-NI), Li-ion battery pack (BAT-LI) and Alkaline dry cells (BAT-AL).



NOTE:

Please set this parameter correctly. When the BAT-LI or BAT-AL is selected, previously explained battery charge function can't be performed.

- Cut out the Set Mode Function List below for use as a quick reference.

Reference (Set mode)	
1. BS-ON	Battery Save
2. TIMER	Timer/Busy scan setting
3. BEP-ON	Beep sound
4. 1750	Tone-Burst Frequency setting
5. SFT-OF	CPU Clock Frequency shift
6. BCL-OF	Busy Channle Lock Out
7. T-OFF	TOT (Time-Out-Timer)
8. TP-OFF	TOT Penalty
9. STP-5	Tuning Step
10. SFD-OF	Shift Direction
11. 0.600 (7.600)	Offset Frequency
12. TN-OFF	Tone Squelch
13. 88.5	Tone Frequency
14. DCS-OF	DCS
15. APO-OF	APO (Auto-Power-Off)
16. SKP-OF	Skip Channel
17. ATT-OF	ATT (Attenuator)
18. CHG-ON	Battery Charge
19. BATNI	Battery type

9. Cloning and Packet Operation

9.1 Cloning

The memory data and customized operational parameters can be transferred from a Master unit to other DJ-S17/DJ-S47 (Slave units).

9.1.1 Cable Connection

- Make sure that both units are turned off before connecting the cable.
- Connect the Microphone/Speaker jack on the Master unit with the Slave unit using an optional clone cable (EDS-11) as shown below, then turn on both units.

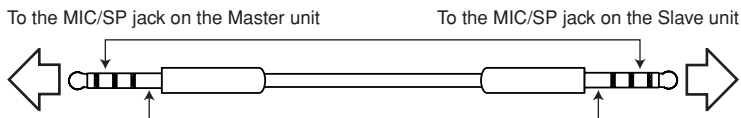

* Be sure to securely screw the plug all the way down to the bottom of the jack.

9.1.2 Master/Slave Units

Press the PTT key three times while holding down the MONI key.

"CLONE" is displayed on the LCD, and both units enter the Clone mode.



9.1.3 Master Unit Operation

1. In the Clone mode, press the PTT key of the master unit. "SD***" is displayed on the LCD, and starts the data-transfer.

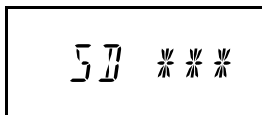

2. After the transfer is completed successfully, "PASS" is displayed.
3. Turn off the unit. Repeat the same sequence to clone more units.

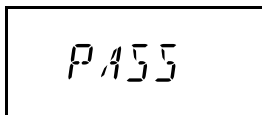

Stop moving the SD***, COMERR etc. on the display means that the cloning is failed. Please read below and repeat the procedure.

9.1.4 Slave Unit Operation

1. When the data is sent from the master unit, "LD***" is displayed on the receiving unit, and the data-transfer starts.

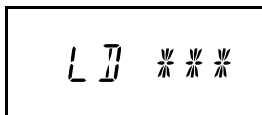

2. After the transfer is completed, "PASS" is displayed.
3. After the cloning is done, turn off the unit by pressing the  key and remove the cable. Repeat the same sequence to clone more units.

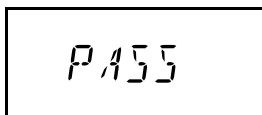

In case the transfer fails, please turn off the slave unit and perform the reset sequence (page 52) to turn on again before retry. If you quit cloning of this slave unit, please reset it anyway otherwise it may not work properly.



Caution

- Don't disconnect the cable during data transmission. If you disconnect the cable at this time, "COMERR" is displayed on the LCD of the master unit, and transmission is aborted.
- When data transfer is performed using the Clone function, all settings in the slave unit are overwritten by the master unit settings.
There is NO data back-up available in unit's memory.

9.2 Packet Operation

Packet operation is one of the data communication methods, which enables data transmission and reception with a personal computer through an optional TNC unit.

9.2.1 Packet Operation Connections

Connect an optional EDS-10 Microphone/Speaker cable plug to the MIC/SP jack on the top of the unit, and connect the TNC (Terminal Node Controller) to the SP jack with 3.5Ø plug, and to MIC jack with 2.5Ø plug on the EDS-10 as shown below.

- Input level adjustment: The unit doesn't have microphone and speaker level adjustment circuit. Adjust their level on the TNC side.
- Output level adjustment: Use the audio output (VOL NAME key) of the unit to adjust the output level from MIC/SP terminal.

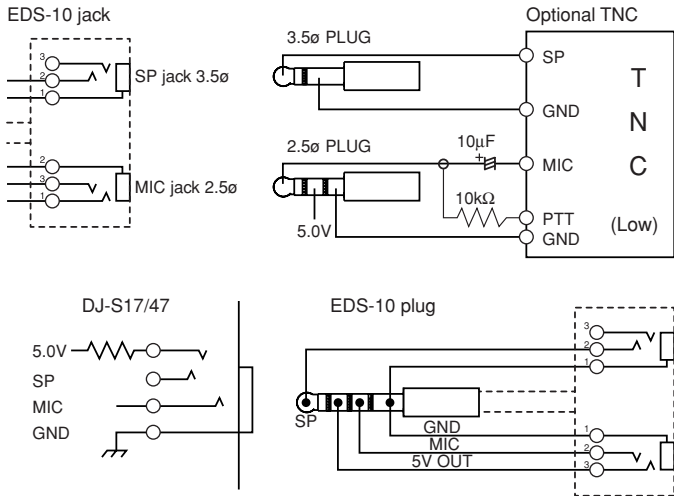

*Power is supplied from internal 5V line through 100Ω resistor.



Caution

- Refer to the TNC's instruction manual when connecting the TNC unit to other devices (personal computer etc.). If the unit, TNC unit and connected personal computer are set too close, noise between them may cause interference.
- Turn the battery save function off during packet operations.
- DJ-S17/DJ-S47 operates up to 1200bps only.

10. Maintenance and Reference

10.1 Troubleshooting

Please check the list below before concluding that the unit needs to be serviced. If a problem persists, please reset the unit. The setting/CPU program-related troubles are often resolved by the reset.

Symptom	Possible Cause	Action
Nothing appears on the display when turning on the power.	Poor battery pack connection.	Check that the battery pack terminals are clean, and pack is correctly attached.
	Battery is exhausted.	Recharge or replace the battery.
No Speaker audio. No reception.	You are releasing the key too quickly.	Hold the power key down until the display shows figures.
	Volume too low.	Adjust the audio level.
	Squelch level too high.	Adjust the squelch.
	Tone squelch is on.	Turn off tone squelch.
	DCS is on.	Turn off DCS.
Frequency display is incorrect.	You are pressing the PTT key and transmitting.	Release PTT key.
	CPU error.	Reset the unit.
Won't scan.	A channel name is set.	See Naming Memory Channels function (page 34).
	Squelch is unmuted.	Set squelch so that noise mutes.
Frequency and memory number don't change.	Keylock is on.	Turn off Keylock.
	Transceiver is in the Call mode.	Select the VFO or Memory mode.
Key entry not possible.	Keylock is on.	Turn off Keylock.
Repeater-Access can't be used.	Incorrect setting of parameters.	Set the correct parameters to suit your local repeaters.
Can't transmit. Display flashes or goes out when you transmit.	Battery is exhausted.	Recharge or replace the battery.
Can't transmit. Can't talk to other stations.	Not pressing the PTT key firmly enough.	Press the PTT key and confirm that TX/RX lamp lights red.
	Off-frequency.	Be sure that you are in the TX range and/or check shift status.
	Incorrect frequency.	Check the shift status/repeater settings.
The display flashes or disappears during reception.	Battery is exhausted.	Recharge battery or replace the battery.

* Please be advised that the water-proof shields including jack caps are subject to consume. The factory warranty for IPX7-grade water-proof is 1 year. Please consult with your local dealer when further service-assistance may be necessary. Please visit alinco.com's "DISTRIBUTION" menu to locate the nearest dealer.

10.2 Resetting

When you reset the unit, all settings are returned to the initial factory settings. The reset deletes the programmed memory channels also.

1. Turn on the unit with the FUNC and  keys pressed together.
2. All the icons appear on the display.

Release the keys. All display will disappear for 2 seconds, and then reappear. The initial mode is the VFO.

Factory default settings

	DJ-S17E	DJ-S17TFH	DJ-S47E
VFO Frequency	145.000MHz	155.000MHz	435.000MHz
CALL Frequency	145.000MHz	155.000MHz	435.000MHz
Memory Channel	0~199ch Blank	0~199ch Blank	0~199ch Blank
Channel Step	12.5kHz	5kHz	12.5kHz
Shift	None	None	None
Offset Frequency	0.6MHz	0.6MHz	7.6MHz
Tone Setting	None	None	None
Tone Frequency	88.5Hz	88.5Hz	88.5Hz
DCS Setting	None	None	None
DCS Code	023	023	023
Transmitter Output	Low	Low	Low
Auto Dialer Code	None	None	None
Keylock	off	off	off
Time-Out-Timer	off	off	off
Auto-Power-Off	off	off	off
Volume Level	0	0	0
Squelch Level	0	0	0
Repeater Shift	-	-	-
Repeater Offset Frequency	0.6MHz	0.6MHz	7.6MHz
Repeater Tone Setting	88.5Hz	88.5Hz	88.5Hz

NOTE:

THE RESET DELETES ALL THE MEMORIES.

Please take notes of the important data and keep it for future reference.

10.3 Options

EBP-63	Li-ion Battery Pack (DC 7.4V 1100mAh)
EBP-64	Li-ion Battery Pack (DC 7.4V 1600mAh)
EBP-65	Ni-MH Battery Pack (DC 7.2V 700mAh)
EBP-66	Ni-MH Battery Pack (DC 7.2V 2000mAh)
EDC-36	Mobile Cigarette Lighter Adapter with Active Noise Filter
EDC-37	External DC Power Supply Cable
EDC-43	Mobile Cigarette Lighter Cable for Charging Ni-MH Packs
EDC-143E/UK	Trickle Battery Charger (E: 230V UK: 230V UK plug)
EDC-143R	Multiple-Charger Basket (An external DC power supply required)
EDC-144E/UK	Rapid Battery Charger (E/UK: same as above)
EDC-144R	Multiple-Charger Basket (An external DC power supply required)
EDC-147	Wall Charger (230V)
EDC-148	Wall Charger (230V) U.K. Plug
EDH-34	Dry Cell Case
EDS-10	Microphone/Speaker Cable
EDS-11	Clone Cable
EME-6	Earphone *
EME-12	Headset with VOX *
EME-13	Earphone and MIC with VOX *
EME-15	Tie-pin MIC with VOX *
EME-20	Earphone Microphone *
EME-32A	Earphone microphone (EDS10 NOT required)
EMS-47	Speaker Microphone with Audio Control *
EMS-59	Speaker Microphone *
EMS-62	Speaker Microphone (EDS10 NOT required)
ESC-41	Soft Case

· Please purchase an optional EDS-10 cable to operate optional accessories marked *.

NOTE:

FOR EUROPEAN USERS:

Please be advised that some of the accessories listed above are not RoHS compliant at the moment this manual has been edited, and they are intended for the sales to where RoHS order is not effective. Please consult with your local dealer for any updates about RoHS compliance of our products before purchase. Use of external power source cables are at your own risk per IEC/EN60950-1. Please refer to "Limited Power Source" on page 8 for details.

IMPORTANT NOTE:

All accessories except EBP-63/64/65/66 and soft cases above listed are NOT water-proof. Never use these accessories in wet conditions.

- When using EDC-36, EDC-37, EDC-43, EDC-146, EDC-147, EDC-148, connect them to the unit first before turning on the unit.
- EBP-63, 64, 65 and 66 are IPX7-grade water-proof only when correctly attached and used with DJ-S17/DJ-S47.

10.3.1 Microphone/Speaker Cable (EDS-10)

1. Turn off the unit.
2. Turn the plug clockwise until it stops. Check to be sure it is securely connected.
3. Connect the Microphone/Speaker plugs to the each jack.

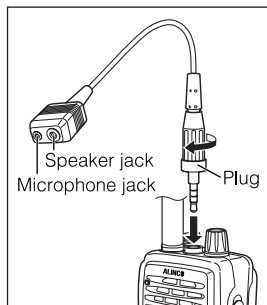

10.3.2 Battery Packs

The battery packs aren't fully charged when shipped. Please charge the pack completely before use.

■ Available Battery Packs for DJ-S17/DJ-S47:

EBP-63	Li-ion Battery Pack (DC 7.4V 1100mAh)
EBP-64	Li-ion Battery Pack (DC 7.4V 1600mAh)
EBP-65	Ni-MH Battery Pack (DC 7.2V 700mAh)
EBP-66	Ni-MH Battery Pack (DC 7.2V 2000mAh)

■ Charging Battery Packs

Refer to the chart below for the combination of the proper battery pack and charger. The ○ indicates the usable combination, (* hrs) means the approximate time necessary to full charge the empty pack.

Chargers	Battery Packs		Ni-MH Battery Pack	
	Li-ion Battery Pack			
	EBP-63	EBP-64	EBP-65	EBP-66
Trickle Charger EDC-143			○(10hrs)	○(14hrs)
Rapid Charger EDC-144	○(2hrs)	○(3hrs)	○(1.5hrs)	○(3.5hrs)
Wall Charger EDC-147/148			○(10hrs)	○(30hrs)

10.3.3 Using the Chargers



Caution

Please also read the "Warning" (page 4 of this manual) and the safety instruction that is included in the accessories' package before operating for your safety.

■ Charging with the EDC-143 (Trickle Charger)

Please make sure that following items are included in the package.

- EDC-143E: EDC-143 basket, EDC-147 adapter (AC 230V), insulation sheet
- EDC-143UK: EDC-143 basket, EDC-148 adapter (AC 230V), insulation sheet
- EDC-143R: EDC-143 basket, connection cable, insulation sheet, 2 screws, connective stay



Caution

Before using them for the first time, attach the insulation sheet to cover the screw-terminals at the bottom to avoid short-circuiting. Please refer to page 60 for instruction.

1. Connect the AC adapter plug to the DC-IN jack on the back of the basket.
*The design of the AC adapter may vary depending on the models.
2. Connect the adapter to an outlet.

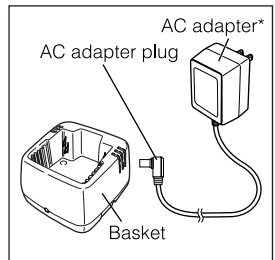

- Press the sides of the adjustment plate, and attach it to the proper grooves of the basket according to the size of the battery pack. Make sure that the characters A, B and C on both sides of the stand match each other and the plate is placed all the way down to the bottom.

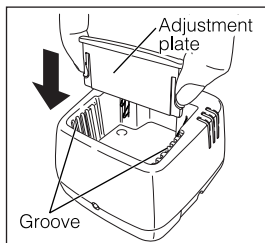

Installation Positions of the Adjustment Plate

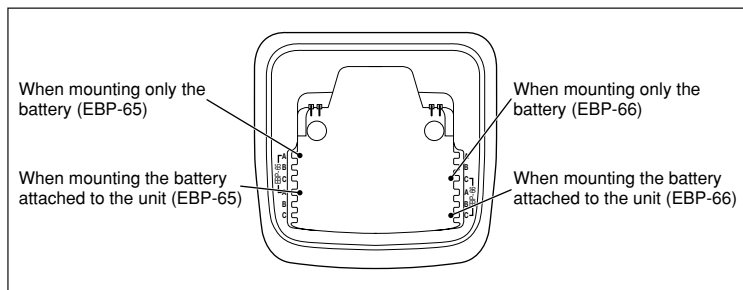

- Mount the battery (with or without being attached to the unit) in the basket as shown. Turn off the unit while charging.

The red indicator on the basket turns on and charging starts.

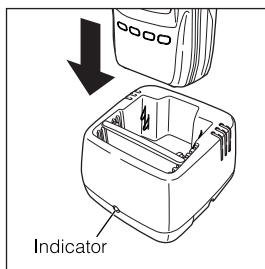

NOTE:

You can charge the battery pack using a basket (EDC-143/144) even if the battery charge function is set to "CHG-OFF".

5. After charging time is elapsed (page 54), remove the battery pack from the basket.
The red indicator stays turned on as long as the pack is mounted on the basket regardless of the charging status.

Specifications

	EBP-65	EBP-66
Input Voltage	DC 12.0V 150mA	DC 12.0V 150mA
Operating Temperature Range	0°C~+40°C (+32°F~+104°F)	0°C~+40°C (+32°F~+104°F)
Charging Current	70mA	140mA
Battery Capacity	DC 7.2V 700mAh	DC 7.2V 2000mAh
Charging Time	Approx. 10 hours	Approx. 14 hours

*The charging time may vary depending on the condition of the battery pack and the temperature of the environment.

NOTE:

Refer to page 59 for information about how to charge the battery using additional baskets.

■ Charging with the EDC-144 (Quick Charger)

Please make sure that following items are included in the package

- EDC-144E: EDC-144 basket, EDC-151 adapter (AC 230V), insulation sheet
- EDC-144UK: EDC-144 basket, EDC-152 adapter (AC 230V), insulation sheet
- EDC-144R: EDC-144 basket, connection cable, insulation sheet, 2 screws, connective stay



Caution

Before using them for the first time, attach the insulation sheet to cover the screw-terminals to avoid short-circuiting. Please refer to page 60 for instruction.

1. Connect the AC adapter plug to the DC-IN jack on the back of the basket.

*The design of the AC adapter may vary depending on the models.

2. Connect the adapter to an outlet.

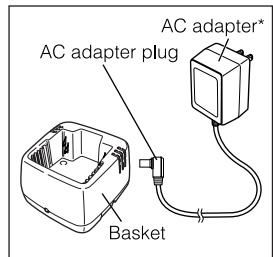

- Press the sides of the adjustment plate, and attach it to the proper grooves of the basket according to the size of the battery pack. Make sure that the characters A, B and C on both sides of the stand match each other and the plate is placed all the way down to the bottom.

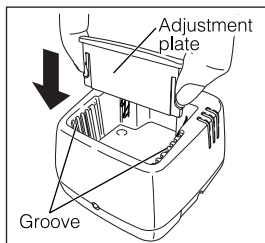

Installation Positions of the Adjustment Plate

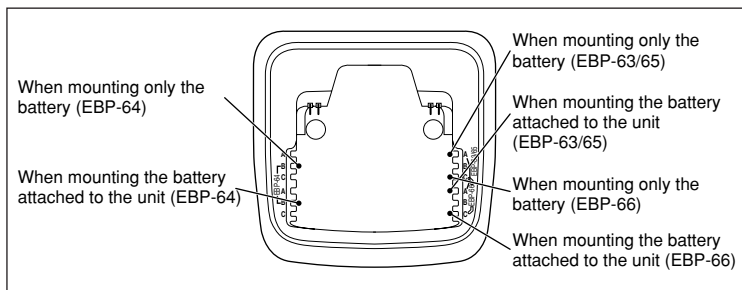

- Mount the battery (with or without being attached to the unit) in the basket as shown. Turn off the unit while charging.

The red indicator on the basket turns on and charging starts.

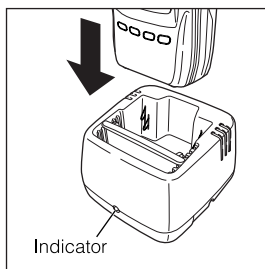

NOTE:

You can charge the battery pack using a basket (EDC-143/144) even if the battery charge function is set to "CHG-OFF".

- The red indicator turns off when the charge is completed. Remove the battery pack from the basket.

NOTE:

The flashing red indicator means that the charger isn't working properly. Stop using it immediately, remove the cord from the outlet and consult with your local Alinco dealer.

Specifications

	EBP-63	EBP-64	EBP-65	EBP-66
Input Voltage	DC 12.0V 700mA			
Operating Temperature Range	0°C~+40°C (+32°F~+104°F)			
Charging Current	600mA			
Battery Capacity	DC 7.4V 1100mAh	DC 7.4V 1600mAh	DC 7.2V 700mAh	DC 7.2V 2000mAh
Charging Time	Approx. 2 hours	Approx. 3 hours	Approx. 1.5 hours	Approx. 3.5 hours

*The charging time may vary depending on the condition of the battery pack and the temperature of the environment.

■ Connecting Additional Baskets (EDC-143R/144R)

In order to use EDC-143R and EDC-144R, an optional power supply (IEC/EN 60950-1 compliant) of 1A/5A minimum respectively is required.

A DC cable isn't included in the package; the suggested DC cable is 20 AWG wire, shorter than 1m (3feet) in length.

- Make sure that the output voltage of the power supply is DC 12.0V.

- Connect the terminals with the provided connection cable, the red cable to the positive and the black cable to the negative terminals.

The additional basket can be connected up to 5 in the same way.

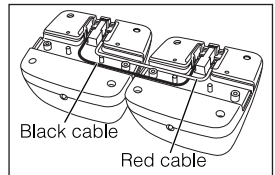

- Connect the ends of the DC cable to the terminals of the basket.

* This DC cable isn't provided in the products.

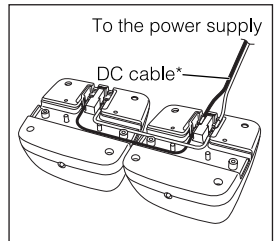

4. Attach the connective stay and the insulation sheets to cover the terminals to avoid short-circuiting.

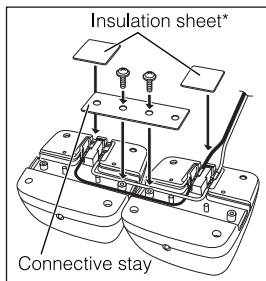

Caution

This insulation sheet marked * is provided to all EDC-143/144 series chargers. Please be sure to cover the bottom of the charger with this sheet as shown above to prevent short-circuiting before using them for the first time.

5. Connect the other ends of the DC cable to the output terminals of the power supply. Be mindful to the polarities of the terminals.

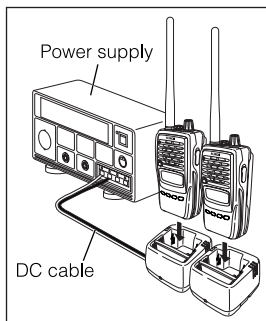

11. Specifications

■ General<DJ-S17>

Frequency range	E:	TX144~145.995MHz	* 144~145.995MHz
		RX144~145.995MHz	* 144~145.995MHz
	TFH:	TX136~173.995MHz	* 150~173.995MHz
		RX130~173.995MHz	* 150~173.995MHz
		* Guaranteed range per specifications	
Modulation:		F3E (FM)	
Frequency step:		5, 10, 12.5, 15, 20, 25, 30kHz step	
Memory channel:		200 channels + 1 call channel + 1 Repeater-Access function memory	
Ant. impedance:		50 Ω unbalanced	
Frequency stability:		±5ppm	
Mic. impedance:		2k Ω	
Supply voltage:		DC 7.0~16.0V (EXT DC-IN)	
Current consumption:		1.4A (typical) Transmit high at 5W	
		250mA (typical) Receive at 500mW	
		70mA (typical) Standby	
		25mA (typical) Battery save on	
Temperature range:		External DC: -10°C~+60°C (+14°F~+140°F)	
		Battery packs: -10°C~+45°C (+14°F~+113°F)	
Ground:		Negative ground	
Dimension:		58(W)x110(H)x36.4(D)mm	
		(2.28"(W)x4.33"(H)x1.43"(D))	
		(with EBP-65)	
Weight:		Approx. 280g (9.9oz)	
		(with EBP-65)	
Sub audible Tone (CTCSS):		encoder/decoder installed (39 tones)	
Sub audible Tone (DCS):		encoder/decoder installed (104 codes)	

■ Transmitter

Power output:	Approx. 5W (with EBP-65) Approx. 5W (with DC 13.8V) Approx. 0.8W (LOW output)
Modulation:	Variable reactance
Spurious emission:	-60dB or less
Max. deviation:	±5kHz
Mic. impedance:	2k Ω

■ Receiver

System:	Double-conversion super heterodyne
Sensitivity:	-14.0dB μ (0.2 μ V) or less
Intermediate frequency:	1st IF 21.7MHz 2nd IF 450kHz
Selectivity	-6dB: 12kHz or more -60dB: 26kHz or less
AF output:	500mW (MAX) 400mW (8 Ω , 10% distortion)

■ General<DJ-S47>

Frequency range	E: TX430~439.995MHz * 430~439.995MHz RX430~439.995MHz * 430~439.995MHz
	* Guaranteed range per specifications
Modulation:	F3E (FM)
Frequency step:	5, 10, 12.5, 15, 20, 25, 30kHz step
Memory channel:	200 channels + 1 call channel + 1 Repeater-Access function memory
Ant. impedance:	50 Ω unbalanced
Frequency stability:	± 2.5 ppm
Mic. impedance:	2k Ω
Supply voltage:	DC 7.0~16.0V (EXT DC-IN)
Current consumption:	1.7A (typical) Transmit high at 5W 250mA (typical) Receive at 500mW 80mA (typical) Standby 27mA (typical) Battery save on
Temperature range:	External DC: -10°C~+60°C (+14°F~+140°F) Battery packs: -10°C~+45°C (+14°F~+113°F)
Ground:	Negative ground
Dimension:	58(W)x110(H)x36.4(D)mm (2.28"(W)x4.33"(H)x1.43"(D)) (with EBP-65)
Weight:	Approx. 280g (9.9oz) (with EBP-65)
Sub audible Tone (CTCSS):	encoder/decoder installed (39 tones)
Sub audible Tone (DCS):	encoder/decoder installed (104 codes)

■ Transmitter

Power output:	Approx. 4.5W (with EBP-65) Approx. 5W (with DC 13.8V) Approx. 0.8W (LOW output)
Modulation:	Variable reactance
Spurious emission:	-60dB or less
Max. deviation:	±5kHz
Mic. impedance:	2k Ω

■ Receiver

System:	Double-conversion super heterodyne
Sensitivity:	-12.0dB μ (0.25 μ V) or less
Intermediate frequency:	1st IF 38.85MHz 2nd IF 450kHz
Selectivity	-6dB: 12kHz or more -60dB: 26kHz or less
AF output:	500mW (MAX) 400mW (8 Ω , 10% distortion)

ALINCO, INC.

Head Office:Shin-Dai building 9th Floor

2-6, 1-Chome, Dojimahama, Kita-ku, Osaka 530-0004, JAPAN

Phone:+81-6-4797-2136 Fax: +81-6-4797-2157

E-mail:export@alinco.co.jp